

SUMIDEROS

CANALES

ACCESORIOS

03

SUMIDEROS



Sumideros sifónicos Salida vertical

Construidos **totalmente** en Acero Inoxidable AISI 304 18/10 decapado, sumideros estancos totalmente soldados, provistos de sistema de retención sifónico y cestillo para recogida de sólidos.

Para medidas y acabados especiales consultar precio.

Opción de rejas tramex, chapa o rosetas en páginas 50-51

DIMENSIONES (mm)	CAUDAL	REF.	PVP(€)
150x150x120 • salida 43Ø	1800 l/h	IDL151SV	120
200x200x175 • salida 90Ø	4300 l/h	IDL202SV	135
300x300x230 • salida 114Ø	5600 l/h	IDL303SV	160
200x200x100 • salida 90Ø altura reducida	4300 l/h	IDL202VR	105
300x300x130 • salida 114Ø altura reducida	5600 l/h	IDL303VR	115

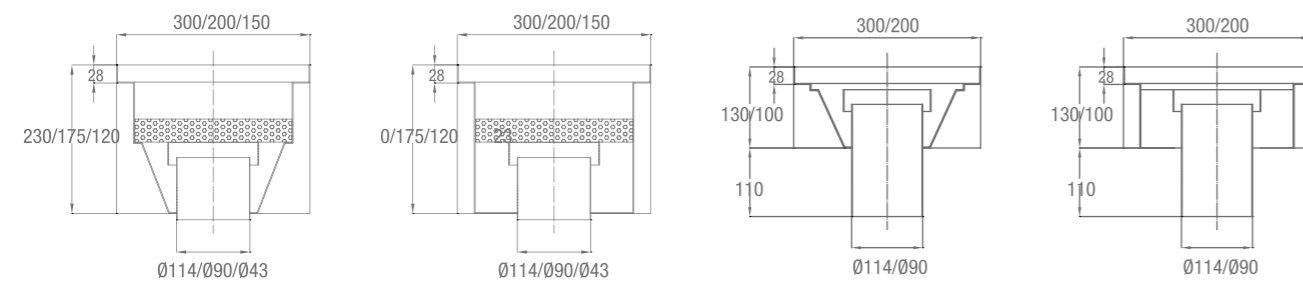

Sumideros sifónicos Salida horizontal

DIMENSIONES (mm)	CAUDAL	REF.	PVP(€)
150x150x120 • salida 43Ø	650 l/h	IDL151SH	130
200x200x175 • salida 90Ø	2800 l/h	IDL202SH	145
300x300x230 • salida 114Ø	4600 l/h	IDL303SH	160
200x200x100 • salida 90Ø altura reducida	2800 l/h	IDL202HR	125
300x300x200 • salida 114Ø altura reducida	4600 l/h	IDL303HR	150

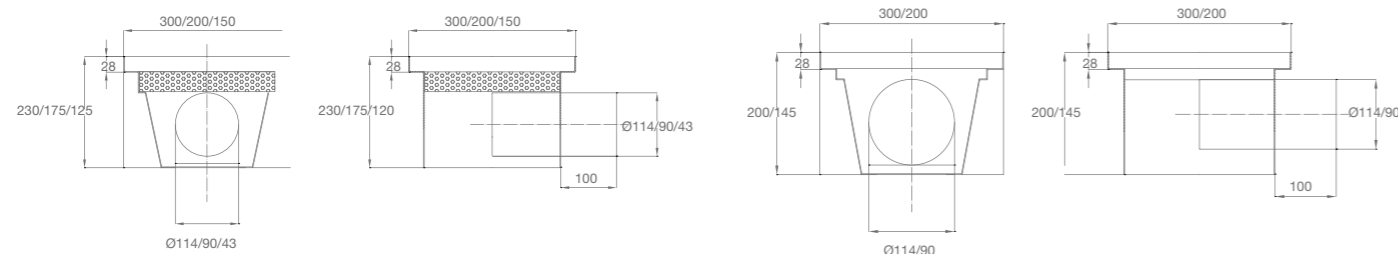

Canales cocina Con sumidero

Construidos **totalmente** en Acero Inoxidable AISI 304 18/10 decapado, canales y sumideros estancos totalmente soldados, provistos de sistema de retención sifónico y cestillo para recogida de sólidos.

Para medidas y acabados especiales consultar precio.

Opción de rejas tramex, chapa o rosetas en páginas 50-51

Salida vertical

DIMENSIONES (mm)	REF.	PVP(€)
503x153x50/120 • salida 40Ø	IDL1505V	210
1003x153x50/120 • salida 40Ø	IDL1510V	285
1503x153x50/120 • salida 40Ø	IDL1515V	320
2003x153x50/120 • salida 40Ø	IDL1520V	370
2503x153x50/120 • salida 40Ø	IDL1525V	425
3003x153x50/120 • salida 40Ø	IDL1530V	475

Caudal 1800 l/h.

DIMENSIONES (mm)	REF.	PVP(€)
503x253x50/120 • salida 90Ø	IDL2505V	310
1003x253x50/120 • salida 90Ø	IDL2510V	375
1503x253x50/120 • salida 90Ø	IDL2515V	440
2003x253x50/120 • salida 90Ø	IDL2520V	500
2503x253x50/120 • salida 90Ø	IDL2525V	565
3003x253x50/120 • salida 90Ø	IDL2530V	640

Caudal 4300 l/h.

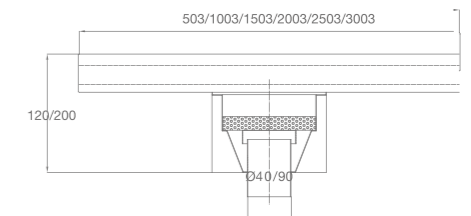
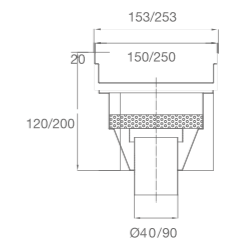

Salida horizontal

DIMENSIONES (mm)	REF.	PVP(€)
503x153x50/120 • salida 40Ø	IDL1505H	225
1003x153x50/120 • salida 40Ø	IDL1510H	275
1503x153x50/120 • salida 40Ø	IDL1515H	325
2003x153x50/120 • salida 40Ø	IDL1520H	385
2503x153x50/120 • salida 40Ø	IDL1525H	440
3003x153x50/120 • salida 40Ø	IDL1530H	490

Caudal 650 l/h

DIMENSIONES (mm)	REF.	PVP(€)
503x253x50/120 • salida 90Ø	IDL2505H	320
1003x253x50/120 • salida 90Ø	IDL2510H	385
1503x253x50/120 • salida 90Ø	IDL2515H	450
2003x253x50/120 • salida 90Ø	IDL2520H	510
2503x253x50/120 • salida 90Ø	IDL2525H	580
3003x253x50/120 • salida 90Ø	IDL2530H	650

Caudal 2800 l/h.

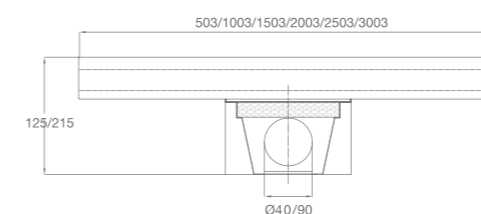
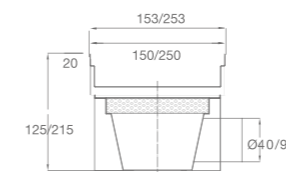

Canales cocina Salida directa

Construidos **totalmente** en Acero Inoxidable AISI 304 18/10 decapado, sumideros estancos totalmente soldados.

Para medidas y acabados especiales consultar precio.

Opción de rejas tramex, chapa o rosetas en páginas 50-51

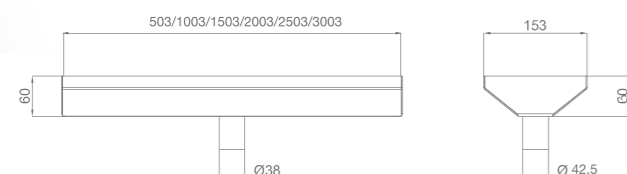

Salida vertical

DIMENSIONES (mm)	REF.	PVP(€)
503x153x60 • salida 42.5ø	IDL105DV	85
1003x153x60 • salida 42.5ø	IDL110DV	115
1503x153x60 • salida 42.5ø	IDL115DV	155
2003x153x60 • salida 42.5ø	IDL120DV	190
2503x153x60 • salida 42.5ø	IDL125DV	240
3003x153x60 • salida 42.5ø	IDL130DV	290

Caudal 1800 l/h

Salida horizontal

DIMENSIONES (mm)	REF.	PVP(€)
503x153x70 • salida 42.5ø	IDL105DH	85
1003x153x70 • salida 42.5ø	IDL110DH	115
1503x153x70 • salida 42.5ø	IDL115DH	155
2003x153x70 • salida 42.5ø	IDL120DH	190
2503x153x70 • salida 42.5ø	IDL125DH	240
3003x153x70 • salida 42.5ø	IDL130DH	290

Caudal 1800 l/h

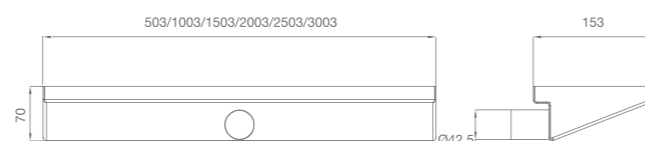
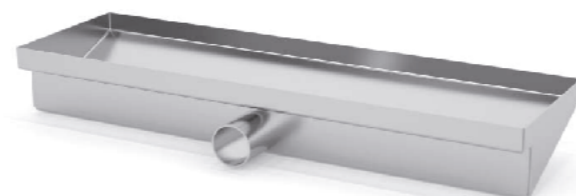

Salida lateral

DIMENSIONES (mm)	REF.	PVP(€)
503x153x60 • salida 42.5ø	IDL105DL	85
1003x153x60 • salida 42.5ø	IDL110DL	115
1503x153x60 • salida 42.5ø	IDL115DL	155
2003x153x60 • salida 42.5ø	IDL120DL	190
2503x153x60 • salida 42.5ø	IDL125DL	240
3003x153x60 • salida 42.5ø	IDL130DL	290

Caudal 1800 l/h

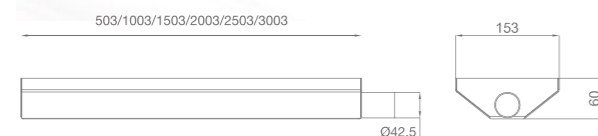

Canales cocina Salida directa

Para medidas y acabados especiales consultar precio.

Opción de rejas tramex, chapa o rosetas en páginas 50-51

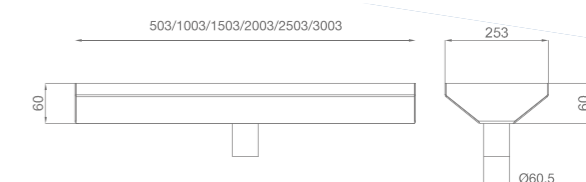

Salida vertical

DIMENSIONES (mm)	REF.	PVP(€)
503x253x60 • salida 60.5ø	IDL205DV	105
1003x253x60 • salida 60.5ø	IDL210DV	140
1503x253x60 • salida 60.5ø	IDL215DV	180
2003x253x60 • salida 60.5ø	IDL220DV	225
2503x253x60 • salida 60.5ø	IDL225DV	285
3003x253x60 • salida 60.5ø	IDL230DV	340

Caudal 3050 l/h

Salida horizontal

DIMENSIONES (mm)	REF.	PVP(€)
503x253x90 • salida 60.5ø	IDL205DV	105
1003x253x90 • salida 60.5ø	IDL210DV	140
1503x253x90 • salida 60.5ø	IDL215DV	180
2003x253x90 • salida 60.5ø	IDL220DV	225
2503x253x90 • salida 60.5ø	IDL225DV	285
3003x253x90 • salida 60.5ø	IDL230DV	340

Caudal 3050 l/h

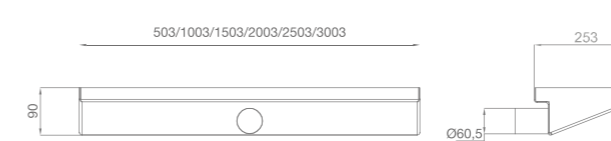
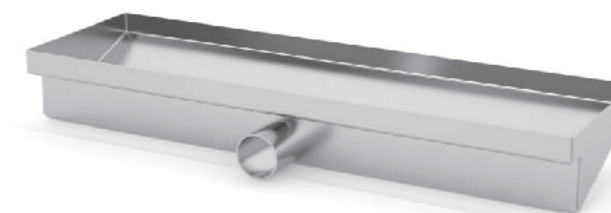

Salida lateral

DIMENSIONES (mm)	REF.	PVP(€)
503x253x80 • salida 60.5ø	IDL205DV	105
1003x253x80 • salida 60.5ø	IDL210DV	140
1503x253x80 • salida 60.5ø	IDL215DV	180
2003x253x80 • salida 60.5ø	IDL220DV	225
2503x253x80 • salida 60.5ø	IDL225DV	285
3003x253x80 • salida 60.5ø	IDL230DV	340

Caudal 3050 l/h

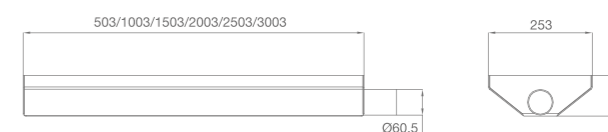

Tramex y rejas modulares Para sumideros y canales cocina

Construidos **totalmente** en Acero Inoxidable AISI 304 18/10 decapado, Tramex de chapa 2mm espesor, separación 23x23mm entre ejes.
Rejas de chapa 1.5mm de espesor, separación 15 mm entre lamas.

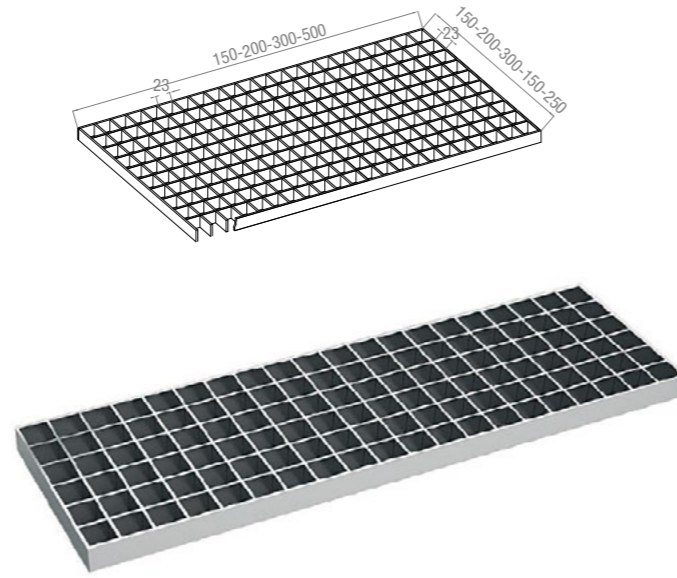

DIMENSIONES (mm)	REF.	PVP(€)
150x150x20	IDLRT150	70
200x200x20	IDLRT200	85
300x300x20	IDLRT300	125
500x150x20	IDLRT515	130
500x250x20	IDLRT525	160

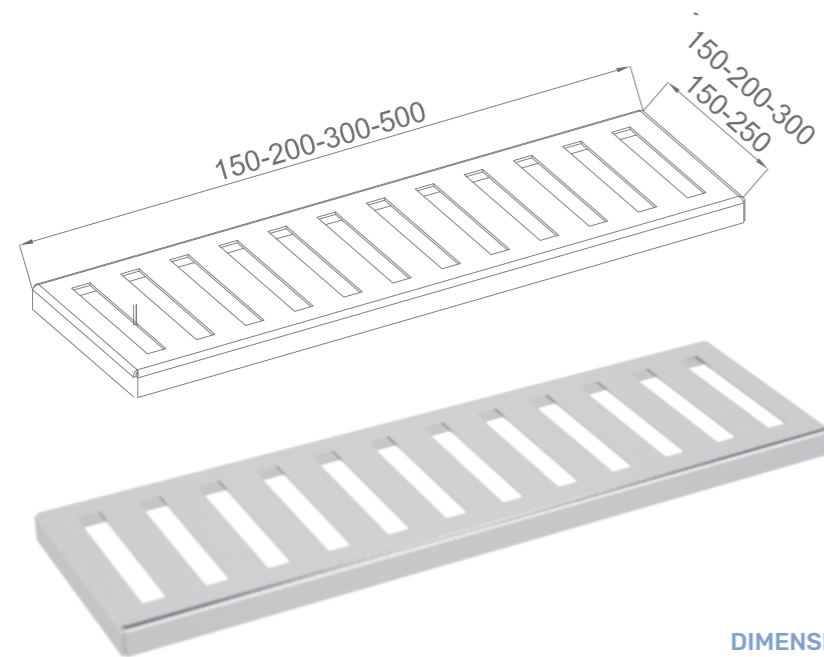

DIMENSIONES (mm)	REF.	PVP(€)
150x150x20	IDLRL150	60
200x200x20	IDLRL200	65
300x300x20	IDLRL300	75
500x150x20	IDLRL515	70
500x250x20	IDLRL525	95

Rosetas modulares de chapa perforada Para sumideros y canales cocina

Construidas **totalmente** en chapa de 2mm de espesor para sumideros, con perforaciones de 22ø para desagüe.

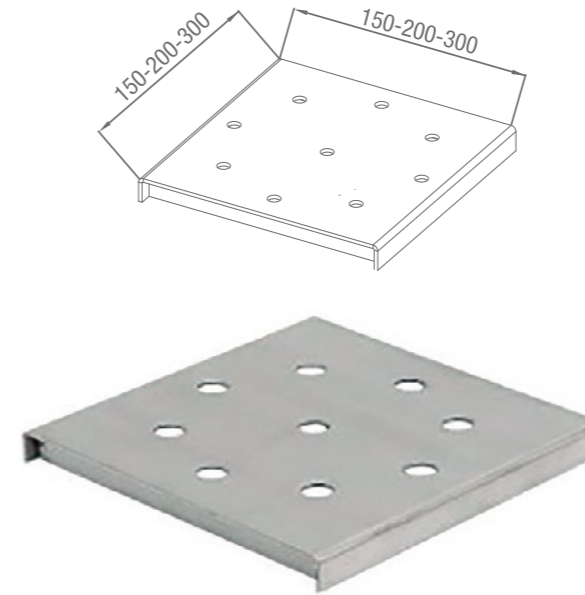

DIMENSIONES (mm)	REF.	PVP(€)
150x150x20	IDLRC150	30
200x200x20	IDLRC200	50
300x300x20	IDLRC300	75

Marcos perimetrales sumideros y canales

Construidos **totalmente** en Acero Inoxidable AISI 304 18/10 , preparados para rematar sumideros y canales contra el pavimento.

Para medidas y acabados especiales consultar precio

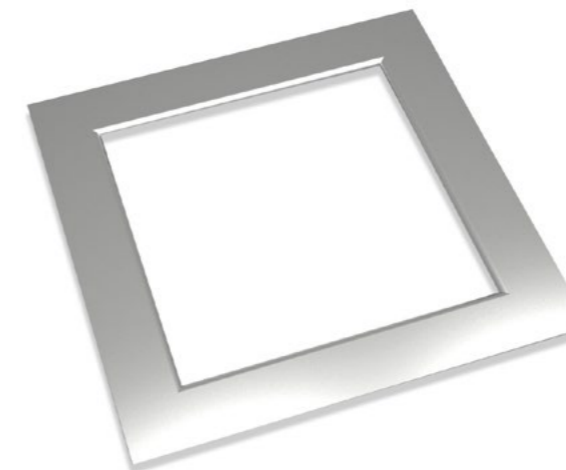

NOVEDAD

DIMENSIONES (mm)	REF.	PVP(€)
150x150x20/20	IDL151MP	40
200x200x20/20	IDL202MP	50
300x300x20/20	IDL303MP	60

DIMENSIONES (mm)	REF.	PVP(€)
503x153x20/20	IDL105MP	70
1003x153x20/20	IDL110MP	85
1503x153x20/20	IDL115MP	95
2003x153x20/20	IDL120MP	110
2503x153x20/20	IDL125MP	120
3003x153x20/20	IDL130MP	135

DIMENSIONES (mm)	REF.	PVP(€)
503x253x20/20	IDL205MP	80
1003x253x20/20	IDL210MP	95
1503x253x20/20	IDL215MP	105
2003x253x20/20	IDL220MP	120
2503x253x20/20	IDL225MP	130
3003x253x20/20	IDL230MP	145